

Ufficio Tecnico SYSTEM GROUP

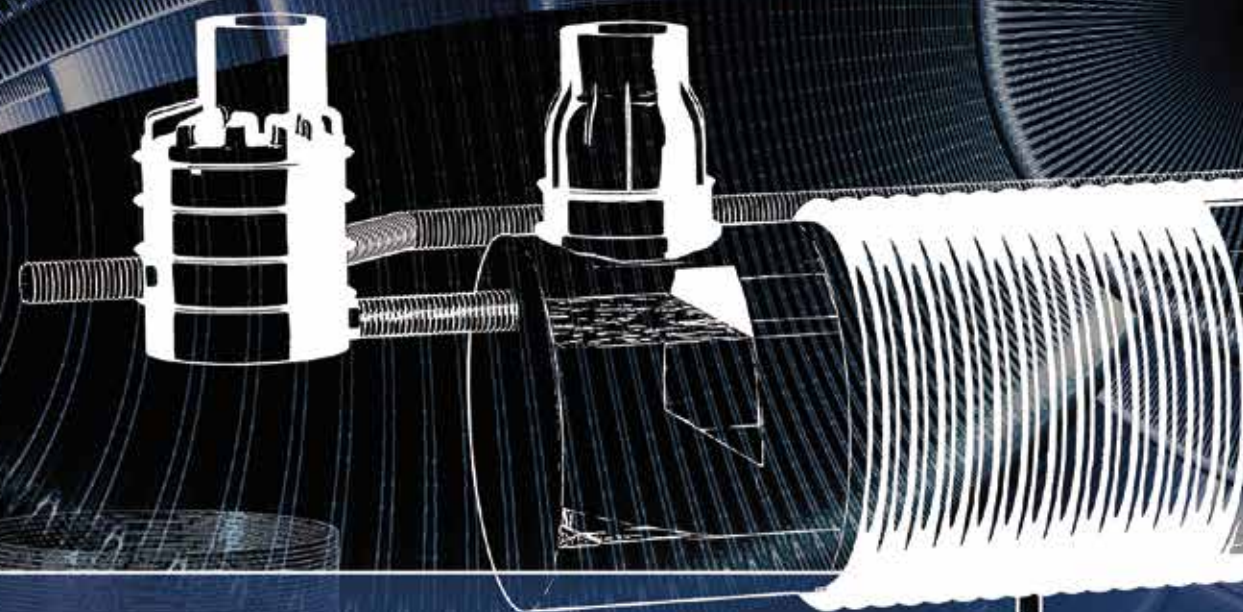

Sistemi completi di canalizzazione

Progettazione
Cantierizzazione
Prototipazione
Assistenza ai collaudi
Verifiche statiche ed idrauliche
Analisi dei prezzi
Redazione manuali tecnici
Normative

Systèmes complets de canalisation

Phase de projet
Mise en chantier
Prototype
Assistance aux essais
Verifications statiques et hydrauliques
Analyses prix
Redaction de manuels techniques
Reglementations

Complete canalization systems

Project design
Technical procedures
Prototypes
Testing support
Static and hydraulic controls
Price analysis
Technical manual writing
Regulations

2016

■ SYSTEM GROUP

Presentazione - Introduction - Présentation

L'Ufficio Tecnico del SYSTEM GROUP è una struttura tecnica a supporto di tutti coloro che desiderano confrontare le proprie valutazioni, progetti e idee con personale tecnico competente e in grado di sviluppare soluzioni standard o ottimizzarle su misura. La centralità dello studio delle soluzioni consente al personale del Dipartimento Tecnico di maturare continue e molteplici competenze, nonché di porle a disposizione in maniera integrata e veloce. Il continuo affinamento e l'ottimizzazione delle soluzioni proponibili, nel rispetto di tutti i suddetti parametri, **costituisce un ulteriore importante valore aggiunto che le aziende del SYSTEM GROUP offrono a tutti coloro che ne faranno richiesta in un'ottica di stretta quanto reciproca collaborazione.** L'Ufficio Tecnico del SYSTEM GROUP è attualmente costituito da figure tutte operanti insieme in una struttura dedicata all'interno di CENTRALTUBI S.p.A.. Le differenti competenze specialistiche dei suoi componenti si integrano in un lavoro di squadra capace di generare risultati completi e di crescente livello qualitativo.

 The SYSTEM GROUP Technical Office is a service that is offered to all those who wish to discuss their own assessments, plans and ideas with competent technical staff able to develop standard or made to measure solutions. The central aspect of the study of solutions allows the staff in the Technical Department to build on their knowledge and place this at the disposal in an integrated and speedy manner. The continuous streamlining and optimisation of the possible solutions, in keeping with all the aforementioned parameters, **is an important additional service that the companies of SYSTEM GROUP offer all those that request it within a close and mutual collaboration.** The SYSTEM GROUP Technical Office currently comprises 5 people who all work together inside the premises of CENTRALTUBI S.p.A.. Their different specialist abilities are linked to a teamwork that offers complete results and a high level of quality.

 Le Bureau Technique du SYSTEM GROUP est une structure technique s'adressant à tous ceux qui souhaitent discuter de leurs travaux, projets et idées avec un personnel technique et compétent à même de développer des solutions standard ou sur mesure. La centralité de l'étude des solutions permet au personnel du Département Technique d'avoir des compétences multiples et continues et de les mettre au service de manière intégrée et rapide. L'amélioration constante et l'optimisation des solutions que l'on propose - dans le respect des paramètres sus-mentionnés - **constitue une ultérieure importante valeur ajoutée que les entreprises du SYSTEM GROUP offrent à tous ceux qui le demandent, dans une optique de collaboration étroite et réciproque à la fois.** Actuellement le Bureau Technique du SYSTEM GROUP est constitué de 5 unités, opérant ensemble dans une structure spécifique à l'intérieur de CENTRALTUBI S.p.A.. Les différentes compétences spécialisées de ses membres s'intègrent dans un travail d'équipe en mesure d'aboutir à des résultats complets et d'une qualité toujours croissante.

Progettazione - Project design - Phase de projet

L'Ufficio Tecnico System Group è di supporto ai tecnici, proponendo varianti e soluzioni tecniche mediante i prodotti System Group, nell'ottica dell'ottimizzazione dei risultati finali. L'ufficio è dotato di personale altamente specializzato nella redazione e predisposizione di disegni tecnici, di layout di stampa e relazioni tecniche di supporto alla progettazione. L'ufficio è in grado di studiare soluzioni per le problematiche più svariate, creando nuovi pezzi speciali per risolvere le situazioni più complesse che si vengono a creare in fase di progetto e di cantierizzazione.

 The Technical System Group supports the project designers, by suggesting a number of technical solutions and variations, through the System Group products, at the most competitive cost. The office is composed of a highly-specialized staff for the elaboration of technical drawings, printing layouts and technical reports, as an integration to the project. The office offers solutions for a wide range of issues, through the creation of new special parts, aimed at providing solutions for the most complex situations emerged during the project design and technical procedures.

 Le Bureau Technique System Group sert de support aux auteurs de projets, proposant des variantes et des solutions techniques au moyen des produits System Group, en cherchant à optimiser les coûts finaux. Le bureau est doté de personnel hautement spécialisé dans la rédaction et la prédisposition de dessins techniques et de layout d'impression et relations techniques de support au projet. Le bureau est en mesure d'étudier des solutions pour les problématiques les plus variées, créant de nouvelles pièces spéciales pour résoudre les situations les plus complexes qui peuvent se créer en phase de projet et de mise en chantier.

Esempi di progettazione:

- (A) Impianti di trattamento acque
- (B) Sistemi di ritenzione
- (C) Tunnel Servizi
- (D) Reti Fognarie

Project examples:

- (A) Water treatment plants
- (B) Retention systems
- (C) Service Tunnel
- (D) Sewage systems

Exemples de projet:

- (A) Traitement des eaux
- (B) Systèmes de rétention
- (C) Tunnel Services
- (D) Réseau d'Egouts

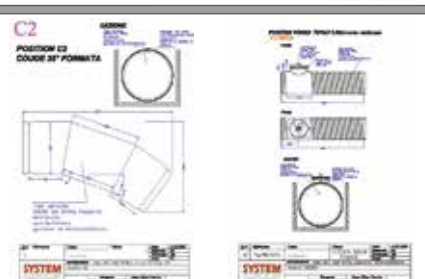
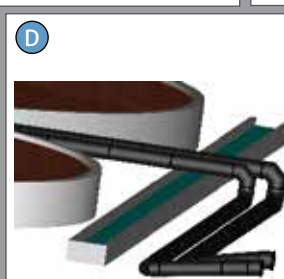
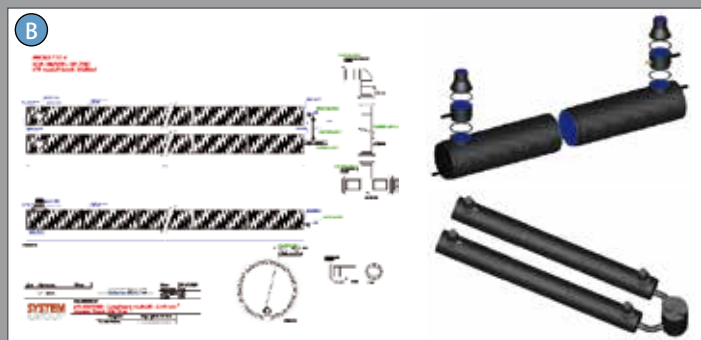

Cantierizzazione - Technical procedures - Mise en chantier

L'Ufficio Tecnico System Group fornisce supporto in fase di cantierizzazione dei prodotti progettati, inoltre effettua dimostrazioni pratiche sull'utilizzo delle attrezzature per l'elettrosaldatura di tubazioni di grosso diametro.

 The Technical Office System Group offers its support during the technical procedures for the designed products. It is also available for training sessions concerning the use of tools for the electrowelding of large-diameter piping.

 Le Bureau Technique System Group fournit un support en phase de mise en chantier des produits projetés, en outre il effectue des démonstrations pratiques sur l'utilisation des équipements pour l'électro-soudure de conduites de gros diamètre.



Milano, depuratore



Ravenna, fognatura



Macerata, accumulo con la valvola di controllo



Austria, impianto di innevamento artificiale



Roma, vasca antincendio



Caserta, vasca volano 400 MC



Roma, pargheggio con accumulo antincendio



Bando di Argenta (FE), accumulo di prima poggia

Prototipazione - Prototypes - Prototypes

L'Ufficio Tecnico System Group è in grado di creare prototipi di nuovi prodotti da lanciare sul mercato, prendendo spunti dalle esigenze commerciali ritenute valide.

 The Technical Office System Group is able to create prototypes for new products to be launched in the market, by drawing inspirations from the most relevant market needs.

 Le Bureau technique System Group est en mesure de créer des prototypes de nouveaux produits à lancer sur le marché, en s'inspirant des exigences commerciales retenues valables.

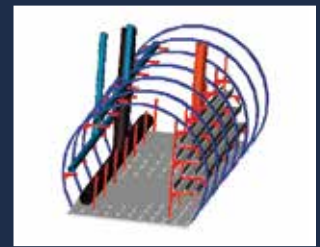

Assistenza collaudi - Testing support - Assistance aux essais

L'Ufficio Tecnico System Group offre l'assistenza in fase di collaudo dei prodotti progettati. In particolare seguendo le normative di riferimento è in grado di concordare le modalità e le procedure di collaudo. L'ufficio è dotato di apparecchiature ad elevata tecnologia per le prove di tenuta delle giunzioni di tubazioni di grosso diametro.

 The Technical Office System Group offers its support during the testing of the designed products. In accordance to the reference regulations, it is particularly able to arrange the testing modalities and procedures. The office is provided with hi-tech resistance testing equipments for the junctions of large-diameter piping.

 Le Bureau Technique System Group offre l'assistance en phase d'essai des produits projetés. En particulier en suivant les réglementations de référence il est en mesure de concorder les modalités et les procédures d'essai. Le bureau est doté d'appareils à technologie élevée pour les essais d'étanchéité des jointures de tuyauteries de gros diamètre.

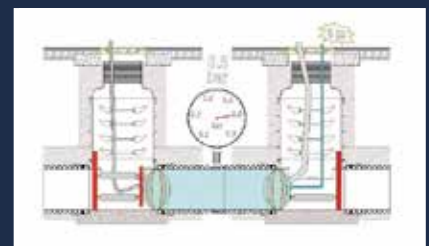



Analisi prezzi - Price analysis - Analyses prix

Redazione di cataloghi tecnici - Technical manual writing

Redaction de manuels techniques

L'Ufficio Tecnico System Group, grazie anche al supporto della vastissima rete commerciale distesa sul territorio nazionale ed internazionale, è in grado di redigere accurate analisi prezzi, di valido supporto al progettista finale. L'Ufficio Tecnico Commerciale System Group partecipa attivamente alla stesura dei manuali tecnici, per quanto concerne i nuovi prodotti.

 The Technical Office System Group, thanks to the support of its wide commercial network, at a national and international level, is able to elaborate detailed price analysis, supporting the final designer. The Technical and Trade Office System Group supports the System Group companies during the technical manual writing concerning new products.

 Le Bureau Technique System Group, grâce également au support du très vaste réseau commercial étendu sur tout le territoire national et international, est en mesure de rédiger des analyses des prix, soutien important pour l'auteur du projet final. Le Bureau Technique Commercial System Group représente un support aux entreprises du System Group pour la rédaction de manuels techniques de nouveau produits.

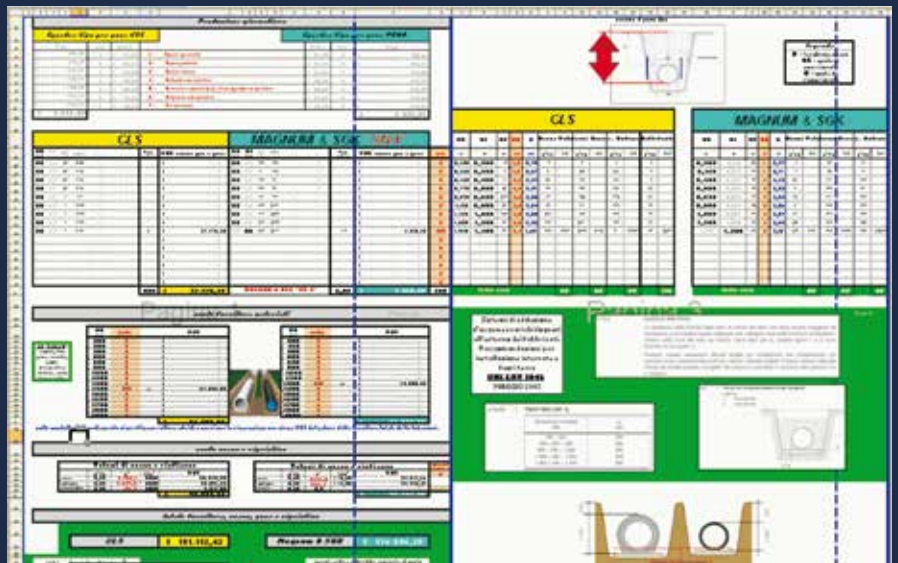

Verifiche statiche ed idrauliche - Static and hydraulic controls

Verifications statiques et hydrauliques

L'Ufficio Tecnico System Group è in grado di fornire supporto al cliente per la redazione di accurate verifiche statiche sulla posa in opera di tubazioni flessibili, rilasciando relazioni di calcolo. Inoltre, con il supporto di software dedicati l'ufficio è in grado di supportare il progettista nella verifica e nella comparazione di portata delle tubazioni.

 The Technical Office System Group is able to offer its support to the customer for the writing of detailed static controls, relative to the implementation of the flexible piping, by releasing the relative calculation reports. Moreover, with the support of specific software, the office is able to support the project designer during the control and comparison of the piping capacity.

 Le Bureau Technique System Group est en mesure de fournir un support au client pour la rédaction de vérifications statiques détaillées sur la pose en oeuvre de tuyauteries flexibles, en délivrant des rapports de calcul. En outre, avec le support de logiciels spécifiques le bureau est en mesure d'apporter un soutien à l'auteur de projets lors de la vérification et la comparaison de portée des canalisations.

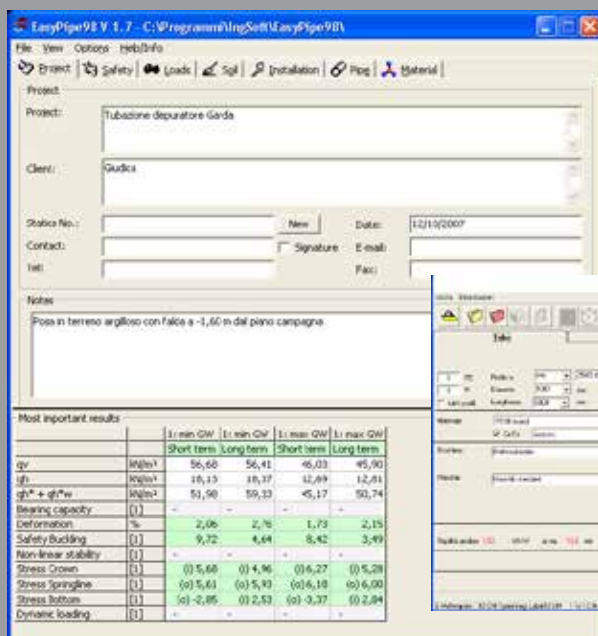

Normative - Regulations - Reglementations

L'Ufficio Tecnico System Group dispone di un ampio archivio di normative che riguardano i sistemi di canalizzazione in materiale termoplastico.

🇬🇧 The Technical System Group is provided with a rich repertoire of regulations, about the canalization systems in thermoplastic material.

🇫🇷 Le Bureau Technique System Group dispose de vastes archives de réglementations qui concernent les systèmes de canalisation en matériau thermoplastique.

Staff Ufficio Tecnico - Technical Office staff - Staff du Bureau Technique

Lo staff dell'ufficio è composto da figure professionali altamente specializzate che hanno maturato esperienza pluriennale nel settore dell'Ingegneria Idraulica, Ambientale e Territoriale, nell'assistenza di cantieri e delle operazioni di collaudo. Il personale è continuamente coinvolto in corsi di aggiornamento, meeting relativi ai sistemi di depurazione e di canalizzazione ed alle normative di settore.

🇬🇧 The office utilises the services of highly specialised staff that has matured many years of experience in the field of hydraulic, environmental and territorial engineering, servicing building sites and final testing operations. Furthermore, inside the office there are professional figures that have worked in the field of research into polyolefines applied to canalisation. The staff is continuously involved in updating courses and meetings for reclamation systems and canalisation and concerning regulations for the sector.

🇫🇷 Le staff du bureau technique vante des professionnels hautement spécialisés, forts d'une longue expérience dans le secteur de l'ingénierie Hydraulique, Environnementale et Territoriale, de l'assistance aux chantiers et aux opérations d'essai. De plus, à l'intérieur du bureau ont été insérés des professionnels ayant de l'expérience dans l'étude et dans la recherche des polioléfines appliquées aux canalisations. Le personnel participe continuellement à des cours de mise à jour et à des séminaires concernant les systèmes de dépuración, de canalisation et les réglementations du secteur.

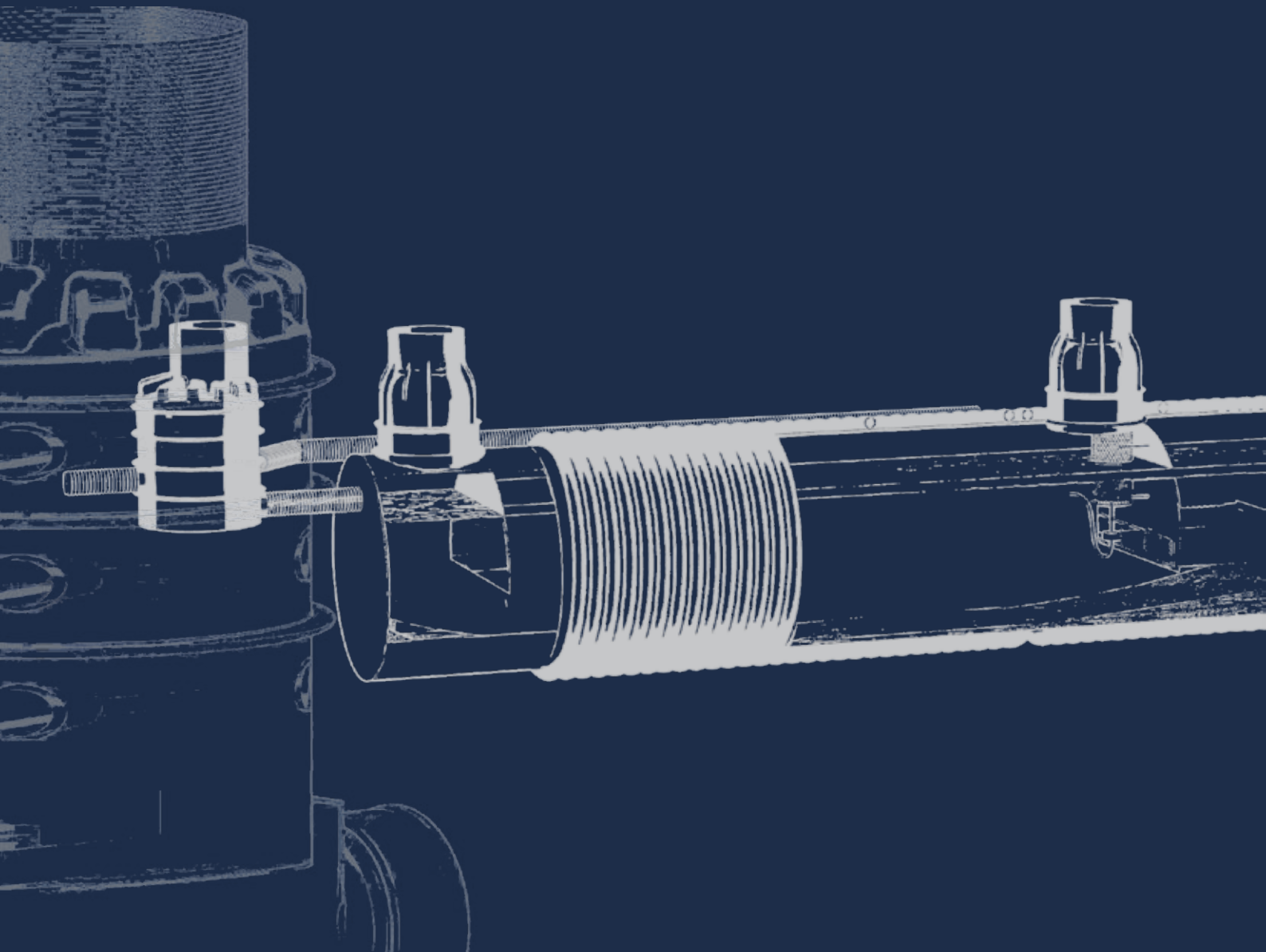



Ufficio Tecnico System Group

61026 **Lunano** (PU) Italy
via Foglia, 11

tel. (+39) **0722 70011**
fax (+39) 0722 70402

www.tubi.net